



FURNITURE SLIDING ROLLER

2023
SUNBEST TRADING

Light Duty Sliding Door Fitting – Load Capacity 15kgs

Order code • **04.341.162.00**
SL 341# Wooden & Framed Door

Product Features

- Weight up to 15kgs
- Toolless door fixing and height adjustment
- Door height : Max. 2000mm
- Door width : Min. 560 - 800mm
- Door thickness : 16 – 25mm

Aluminium, Silver Anodized

Order Code	Length
04.341.025.03	2500mm
04.341.035.03	3500mm

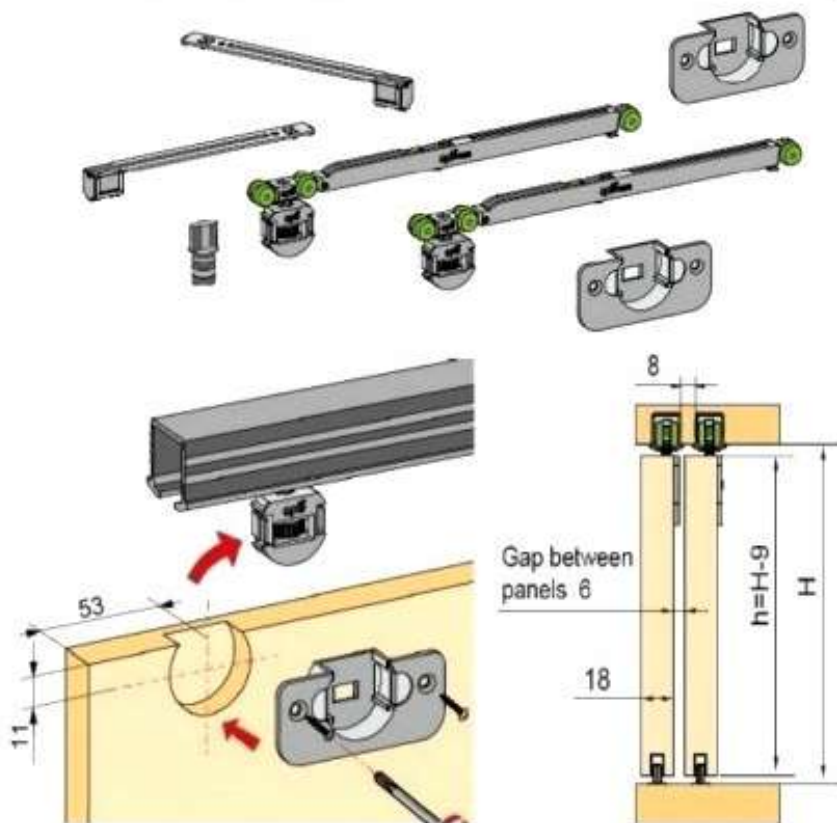
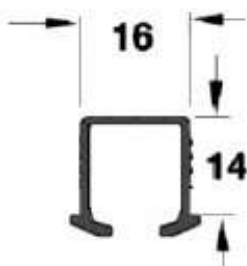

Order code • **04.341.262.00**
SL 341# Glass Door

Product Features

- Weight up to 15kgs
- Toolless door fixing and height adjustment
- Door height : Max. 2000mm
- Door width : Min. 560 - 800mm
- Glass thickness : 5mm

Aluminium, Silver Anodized

Order Code	Length
04.341.025.03	2500mm
04.341.035.03	3500mm

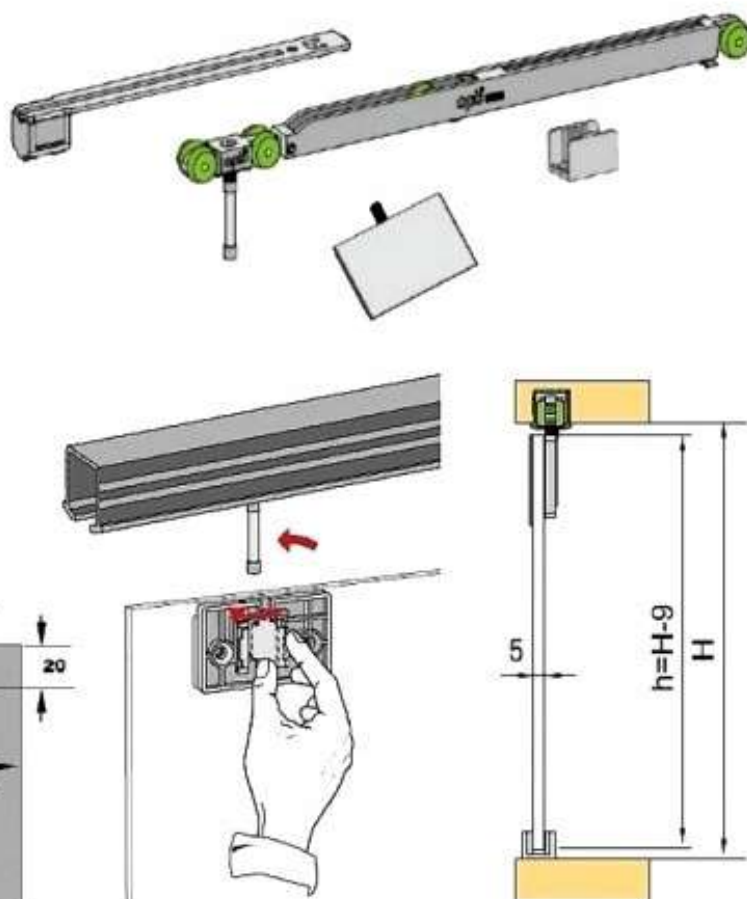
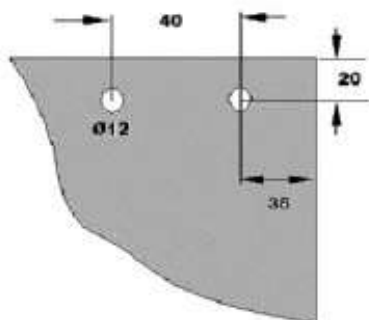
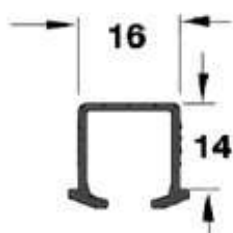

Light Duty Sliding Door Fitting – Load Capacity 30kgs

SL 342# Wooden & framed door without soft close mechanism

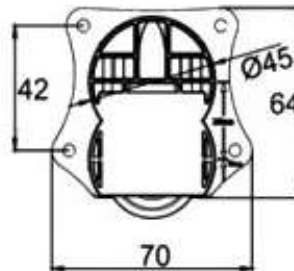

Product Features

- Weight up to 30kgs
- Door height : Max. 2400mm
- Door width : Min. 300 – 400mm
- Door thickness : 16 – 25mm

Order Code	Fitting
04.342.230.00	Top
04.342.130.00	Bottom

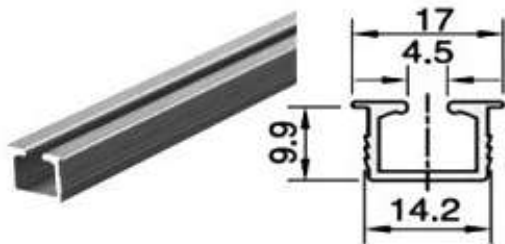

Aluminium, Silver Anodized

Order Code	Length
04.342.020.03	2000mm
04.342.030.03	3000mm
04.342.040.03	4000mm

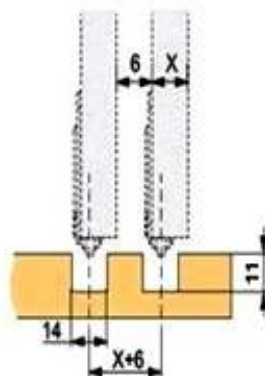
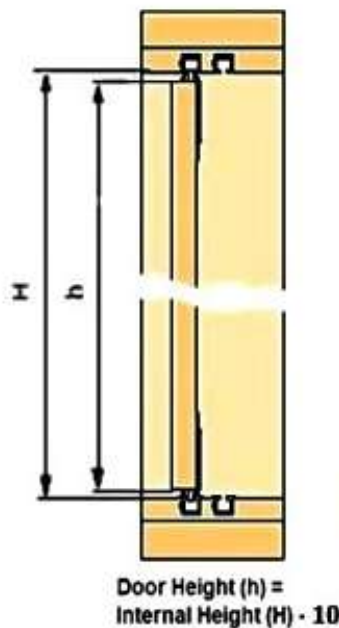

Top & Bottom Roller

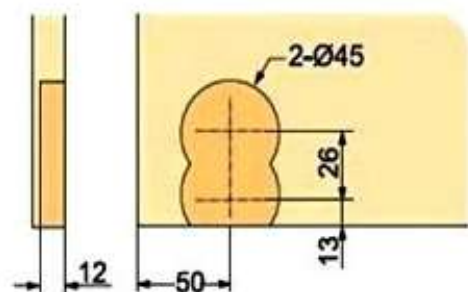

Heavy Duty Sliding Door Fitting – Load Capacity 50kgs

SL 342# Wooden & framed door with soft close mechanism

Product Features

- Weight up to 50kgs
- Door height : Max. 2400mm
- Door width : Min. 630 – 900mm
- Door thickness : 16 – 25mm

Order Code	Fitting
04.342.250.00	Top
04.342.140.00	Bottom

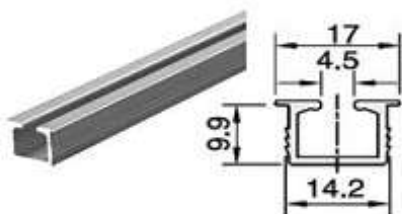

Aluminium, Silver Anodized

Order Code	Length
04.342.020.03	2000mm
04.342.030.03	3000mm
04.342.040.03	4000mm

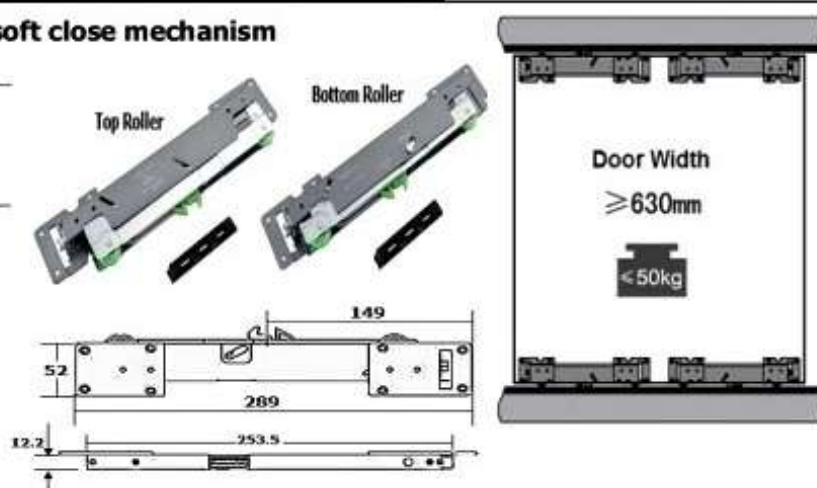

Top Guide and Bottom roller

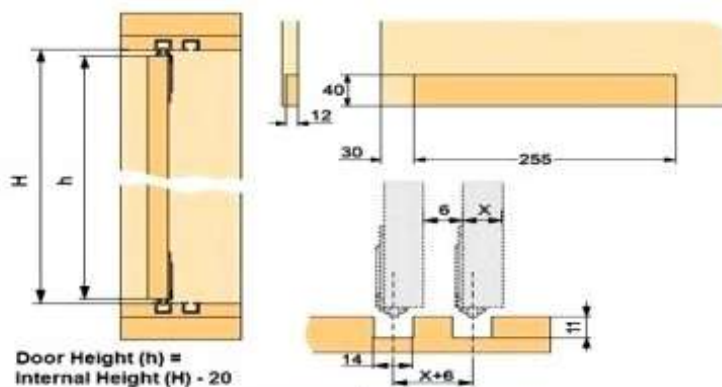

Heavy Duty Sliding Door Fitting – Load Capacity 40kgs

SL 342# Wooden & framed door with soft close mechanism

Product Features

- Weight up to 40kgs
- Door height : Max. 2400mm
- Door width : Min. 630 – 900mm
- Door thickness : 16 – 25mm

Order Code	Fitting
04.342.250.00	Top
04.342.130.00	Bottom

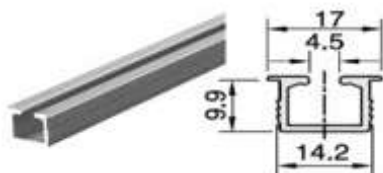

Aluminium, Silver Anodized

Order Code	Length
04.342.020.03	2000mm
04.342.030.03	3000mm
04.342.040.03	4000mm

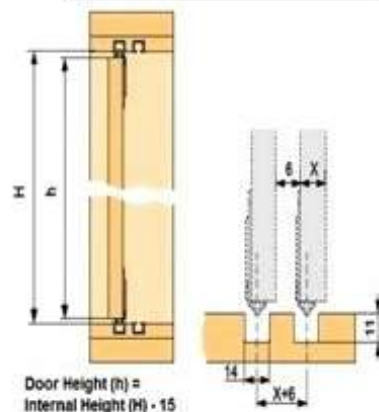
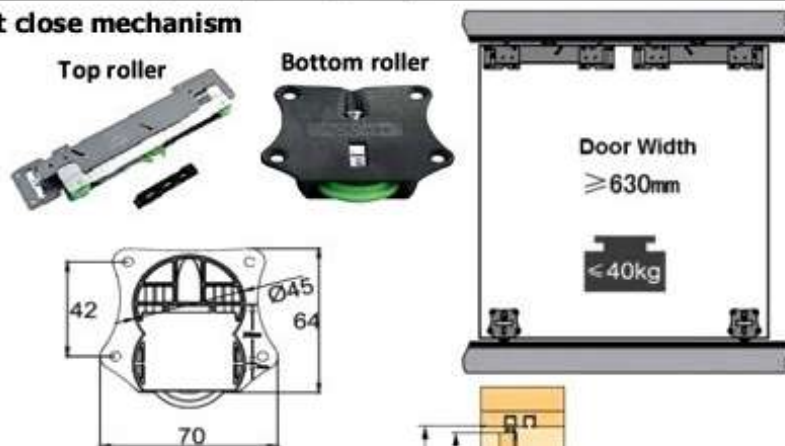

Light Duty Sliding Door Fitting

Order Code	Description
04.353.001.44	Top Guide
04.353.002.44	Bottom Roller

Order Code	Track
04.353.366.44	3600mm, Brown

Product Features

- Material : Plastic
- Max. Door weight : 15kg



Heavy Duty Sliding Roller

Product Features

- Material : Steel plastic
- Max. Door weight : 40kg
- Max. door width : 2000mm
- Max. door height : 2400mm

Sliding Roller Set

Order Code	Description
04.355.035.00	Plate : Grey Colour
04.355.036.00	Plate : Grey Colour



Single Track : Top & Bottom

Order Code	Length
04.355.025.03	2500mm
04.355.030.03	3000mm
04.355.036.03	3660mm
04.355.060.03	6000mm

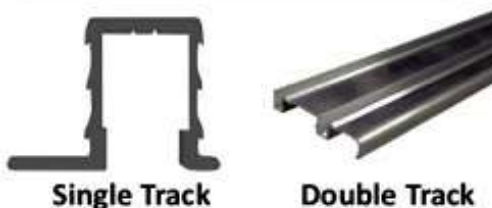

Double Track : Top & Bottom

Order Code	Length
04.355.008.03	2500mm
04.355.032.03	3000mm
04.355.012.03	3600mm
04.355.062.03	6000mm

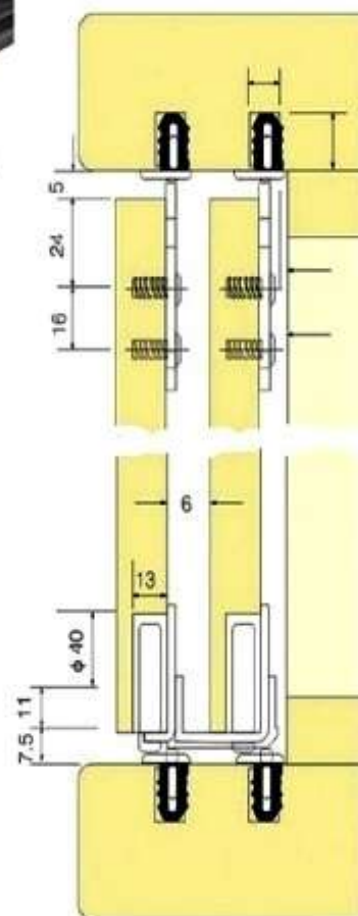

Mini Showcase Cabinet Frameless Glass Door

SL 345



Product Features

- Load Capacity : 15kg
- Easy installation and adjustment, adjust door crack directly
- Buckle-connector adopted, making more beautiful appearance
- Applications : Cabinet door, screen door, bookcase door and wardrobe door etc

Aluminium, Silver Anodized

Description	Order Code	Length
Roller Set	04.345.312.00	-
Top & Bottom Running Profile	04.345.255.03	3000mm
Top & Bottom Frame Profile	04.345.201.03	2000mm

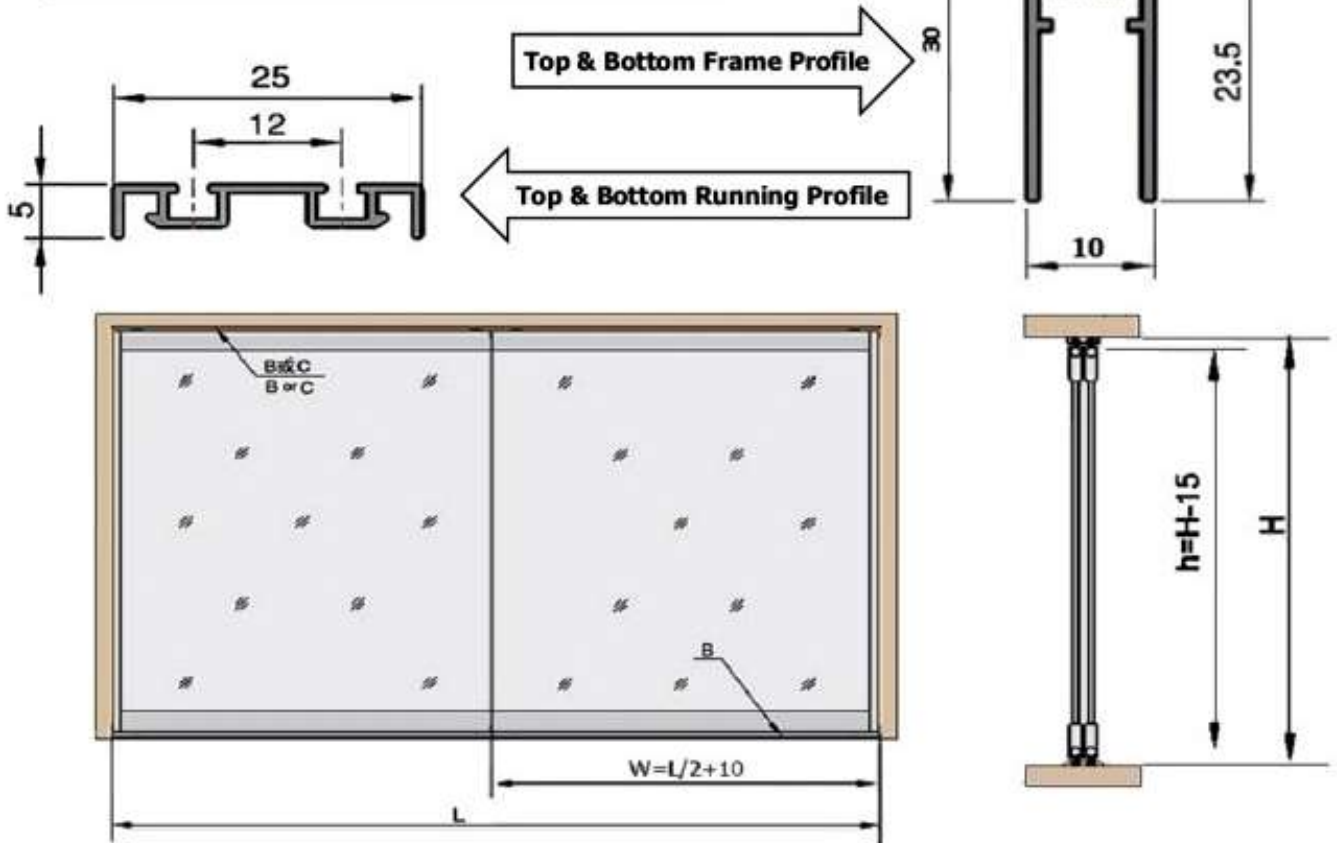

Antijump Sliding Roller With Soft Close

Product Features

- Various roller distance is optional for buyer adjustment
- No need to replace the accessories
- Smooth and long using life
- Easy installation
- No left or right identification

Order Code	Article
04.601.212.00	Top Roller ≤ 15kg
04.601.232.00	Top Roller ≤ 30kg
04.601.252.00	Top Roller ≤ 50kg
F o r 3 D o o r	
04.601.213.00	Top 2 Way Damper 30kg
04.601.223.00	Top Intermediate



2 way Damper

Top intermediate

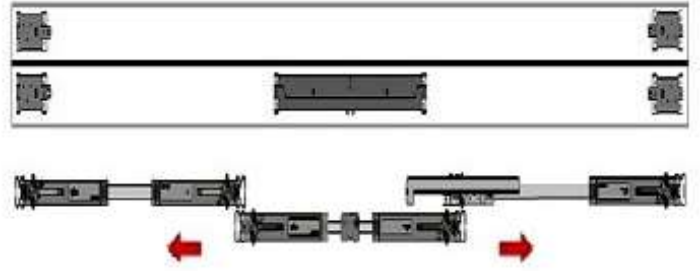

Antijump Sliding Roller

Order code • **04.601.608.00**

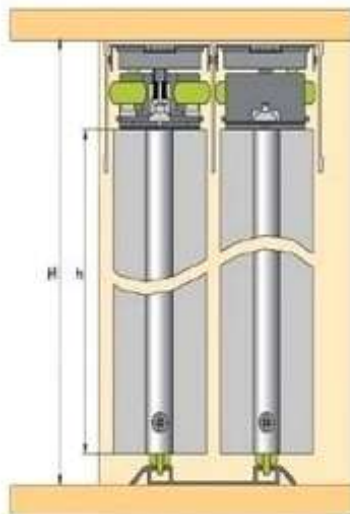

$h = H - 43$

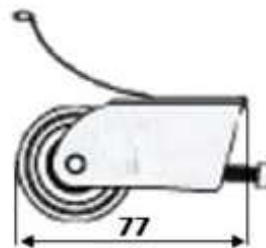

Flat-Front Sliding Door

Order code • **04.374.020.00**



Product Features

- Cabinet inline wooden door
- Door width : 450 – 1000mm
- Weight loading : 20kg
- Door height : 400 – 1200mm
- Rail length : 2000mm
- Packaging include roller & track

Accessories details :

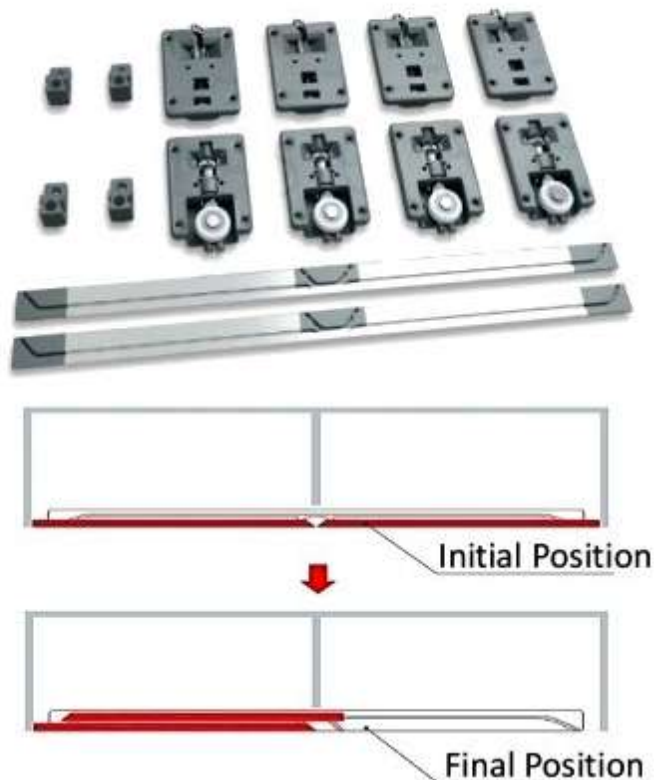
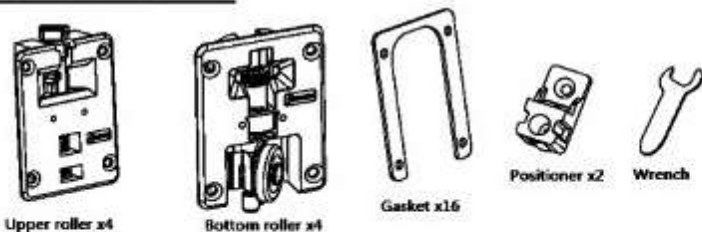

Vertical Synchro Insert Sliding Fitting

Order code • **04.641.002.00**

Product Features

- For wooden doors and wooden or aluminium frame doors
- Door panel weight up to 15kg
- Simple, fast and safe assembly



Surface / Concealed Sliding Roller

Product Features

- Various roller distance is optional for buyer adjustment
- No need to replace the accessories
- Smooth and long using life
- Easy installation
- No left or right identification
- Wooden door thickness : 16 – 25mm
- Both side, invisible damping 50kg for minimum installation width and fixable end position
- Closure / fixation of the end position possible without damping

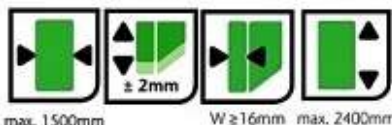

Order Code	Article			
04.343.002.00	Roller			
04.343.003.00	Soft Closing Damper			
07.898.600.03	Al. Profile Handle			
T	R	A	C	K
04.343.225.03	Top Track			
04.343.226.03	Bottom Track		2.44m (8ft)	
04.343.263.03	Cover for T&B Track			
04.343.236.03	Top Track			
04.343.237.03	Bottom Track		3.66m (12ft)	
04.343.264.03	Cover for T&B Track			
04.343.260.03	Top Track			
04.343.261.03	Bottom Track		6.1m (20ft)	
04.343.262.03	Cover for T&B Track			
07.898.600.03	Alu. Profile Handle	6.0m (20ft)		

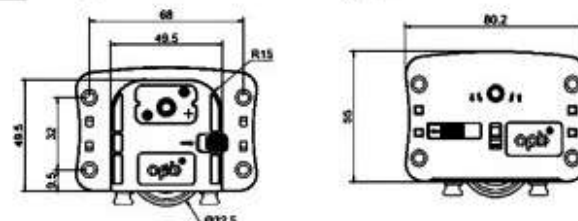

Top & Bottom Roller

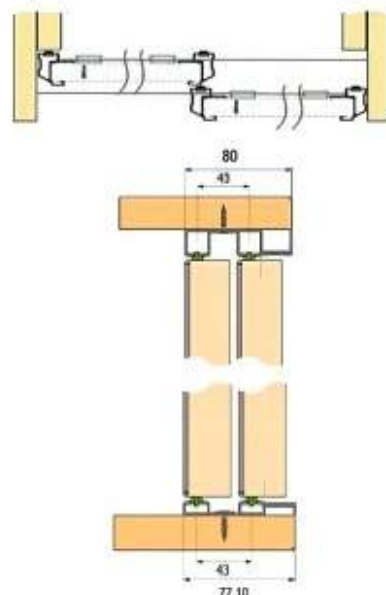
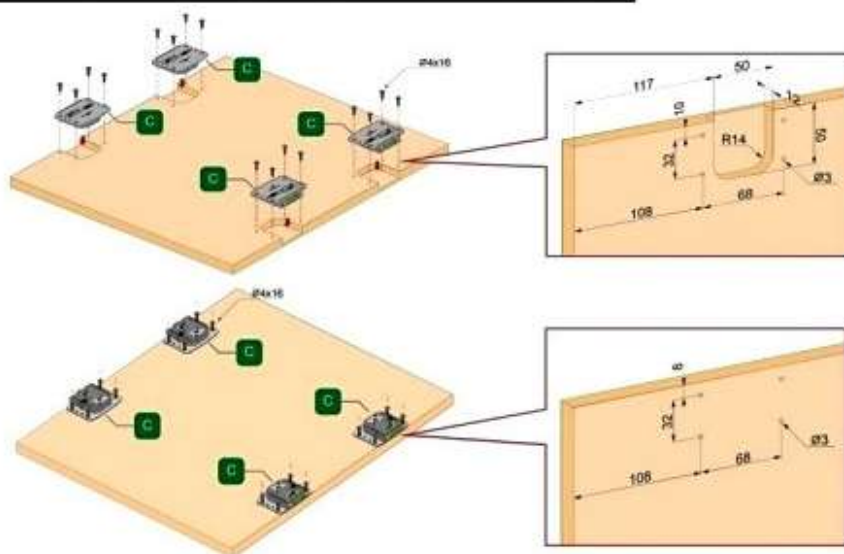
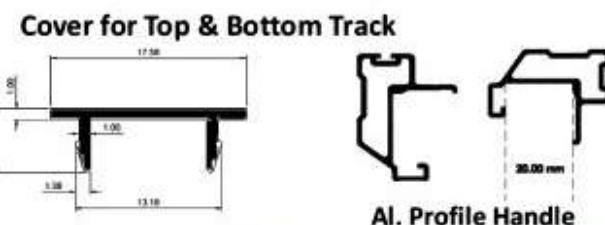
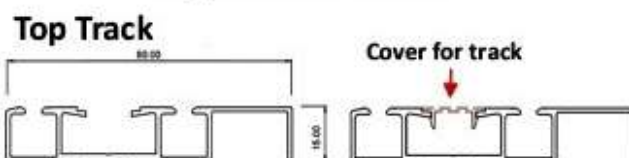

IL 371 In Line Sliding Door

Load capacity 50kg

Order Code	Width
04.371.218.00	1800mm
04.371.219.00	1900mm
04.371.220.00	2000mm
04.371.222.00	2200mm
04.371.224.00	2400mm

Product Features

- Applicable to wooden door & framed door
- Max weight : 50kg panel
- Door thickness : 18 – 50mm
- Door width : 900 – 1500mm
- Door height : 600 – 2800mm

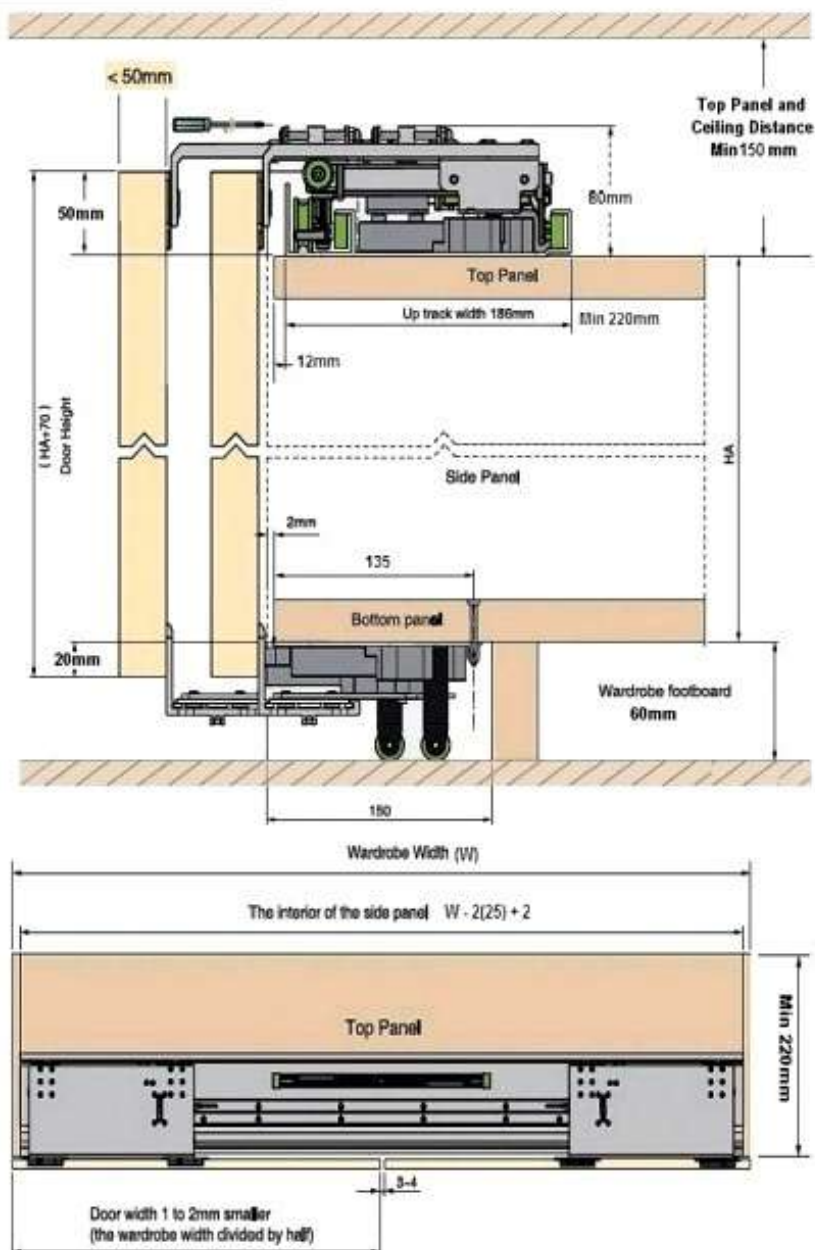
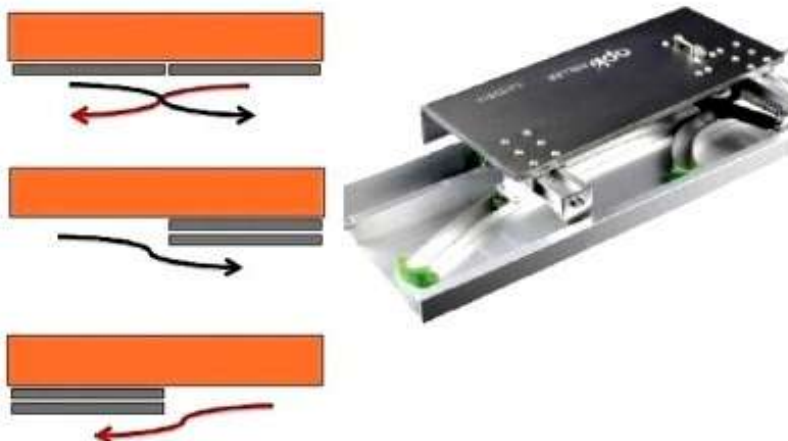

TL 368 Sliding Door Fitting

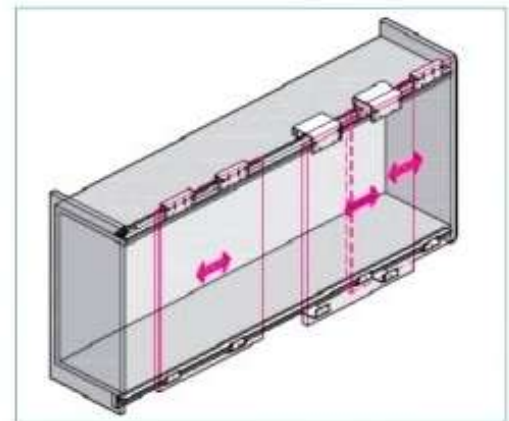

**Picture shown 2 door fitting

Product Features

- TL 368 is sliding door fitting suited for thickness 18 – 40mm
- The design may applicable to wooden doors or aluminium framed doors
- Anti slipping off, smooth and silent movement and its soft close damper

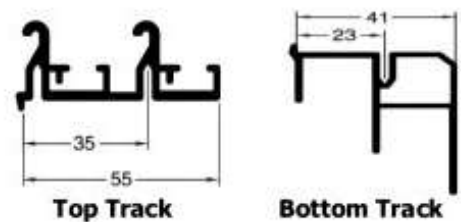

Order Code	Door Fitting
04.368.121.00	Outer Fitting
04.368.111.00	Inner Fitting

Accessories For 3 DOOR

04.368.101.00	Inner for 3 rd Door
04.368.301.00	Metal Bracket
04.601.213.00	2 Way Damper for Centre Door 30kg

Runner Profile

04.368.020.03	2.0m Top
04.368.021.03	2.0m Bottom
04.368.030.03	3.0m Top
04.368.031.03	3.0m Bottom
04.368.040.03	4.0m Top
04.368.041.03	4.0m Bottom
04.368.060.03	6.0m Top
04.368.061.03	6.0m Bottom

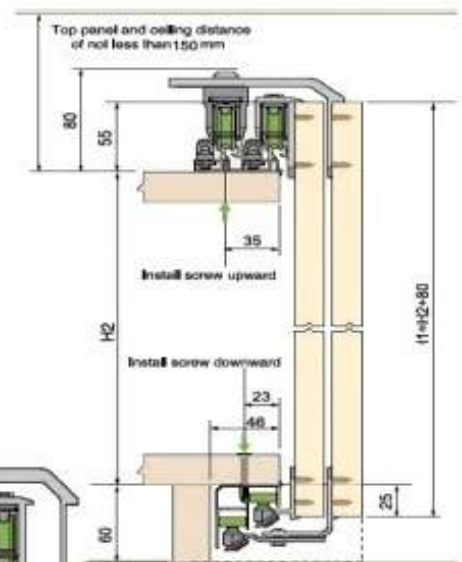
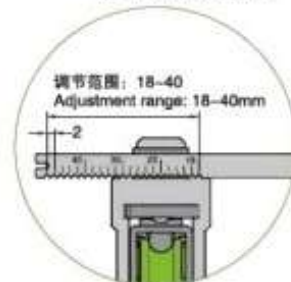
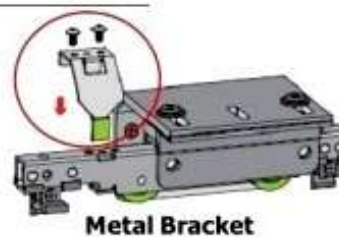

Anti-jump Fittings

Door thickness adjustment Fittings





Prevent exit hock

Min clearance between the two doors - 8mm

Folding Door Roller – WL780

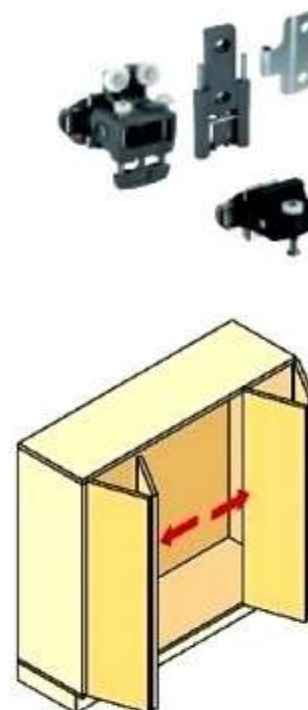
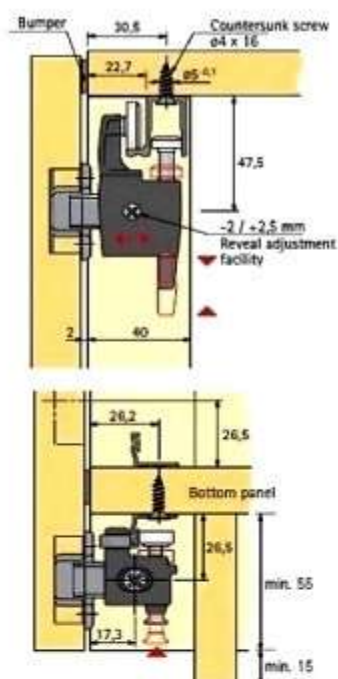

Order code • **04.182.201.42**
For door panel 10kg

Order Code	Shape
Runner Profile 04.180.020.42	
Guide Profile 04.181.020.42	



Folding Door Roller – WL770

Order code • **04.183.201.42**
For door panel 20kg

Order Code	Shape
Runner Profile 04.180.020.42	
Guide Profile 04.181.020.42	

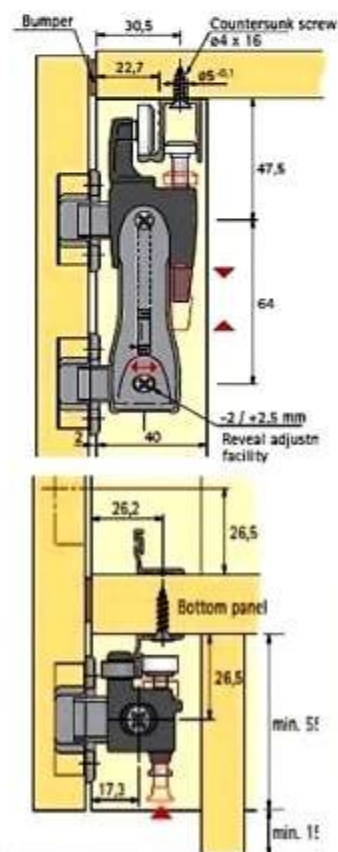

4 Panels Folding & Sliding Door Fitting

Order code • **04.381.400.00**
4 Panel Kit

Product Features

- Door Width : Max. 500 mm
- Door Height : Max. 2500 mm
- Door Thickness : 19 – 25 mm
- Door Weight : Max. 20 kg (40 kg per pair of doors)
- Height Adjustment : +/- 2 mm at top running gear

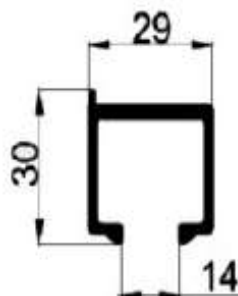
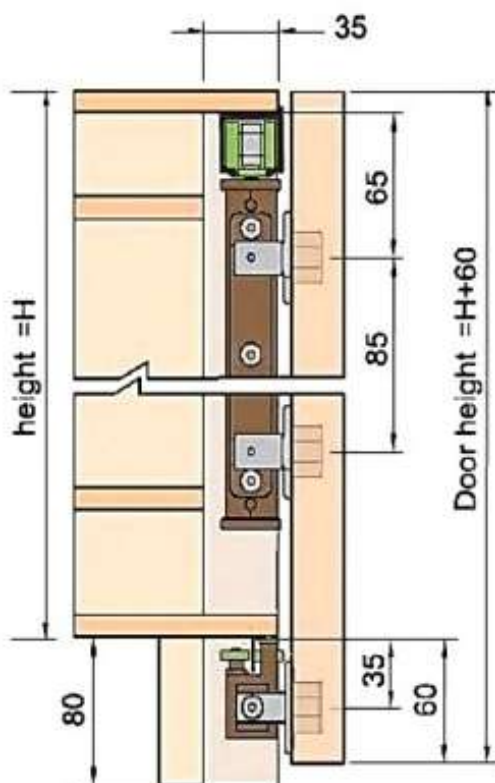
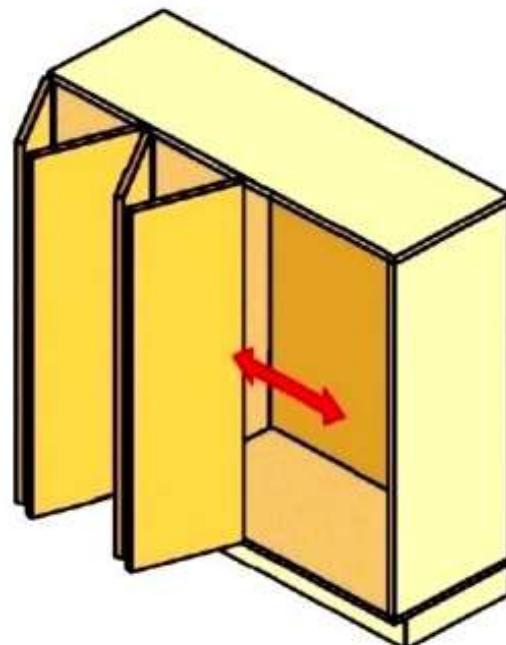

Aluminium Top Track

Order Code	Size
04.381.025.03	2500mm
04.381.035.03	3500mm



Aluminium Bottom Guide Track

Order Code	Size
04.181.020.42	2000mm

Sliding Door Hardware With Double Damper (Soft Closing)

S3 Sliding Door Hardware

Order Code	Article
02.106.062.00	S3

Product Features

- Smooth, steady and silent movement.
- Damper function exists while door opening and closing.
- Self cleaning in the track.
- Adjustable stopper device.
- Vertical and lateral adjustment.

Range of Applications

- For all single-leaf and two leaf sliding doors.
- For all materials, e.g wood, metal and framed door.
- Wall and ceiling mounted.
- Max weight 80kgs
- For door leaf width 600 – 900mm



Order Code	Article
02.151.051.15	Wall Fixing Bracket



Running Profile, Screw On

Finish : Silver anodized aluminium

Order Code	Length
02.134.200.03	2.0m
02.134.250.03	2.5m
02.134.300.03	3.0m
02.134.400.03	4.0m
02.134.600.03	6.0m

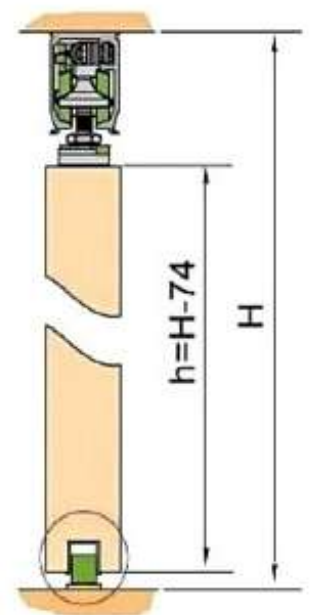
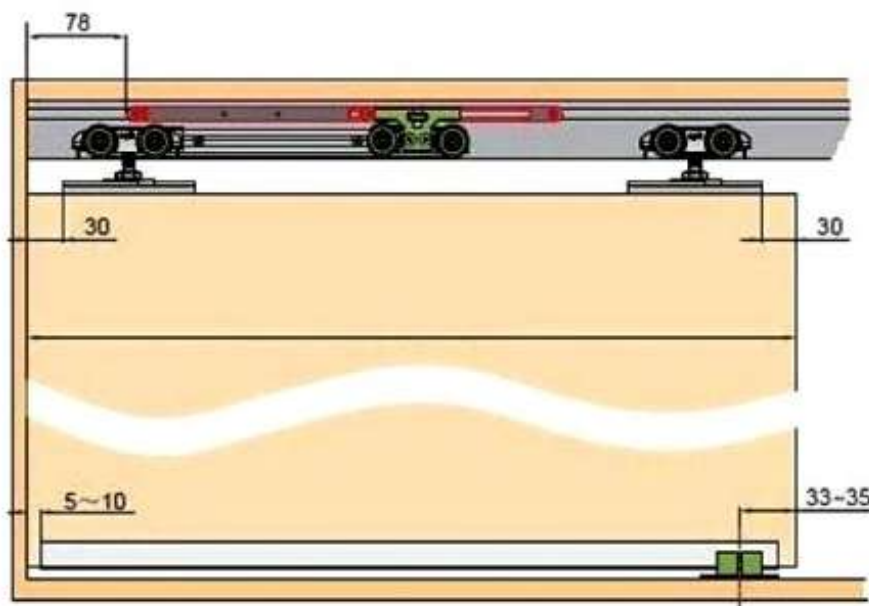

Range of applications

Sliding Door Hardware With Double Damper (Soft Closing)

S4 Sliding Door Hardware

Order Code	Article
02.106.082.00	S4

Product Features

- Smooth, steady and silent movement.
- Damper function exists while door opening and closing.
- Self cleaning in the track.
- Adjustable stopper device.
- Vertical and literal adjustment.
- Easy and simple maintenance.

Range of Applications

- For all single-leaf and two leaf sliding doors.
- For all materials, e.g wood, metal and framed door.
- Wall and ceiling mounted.
- Max weight 80kgs
- For door leaf >900mm



Running Profile, Screw On

Finish : Silver anodized aluminium

Order Code	Length
02.134.200.03	2.0m
02.134.300.03	3.0m
02.134.400.03	4.0m
02.134.600.03	6.0m

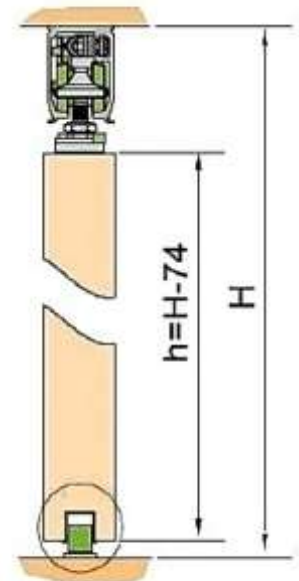
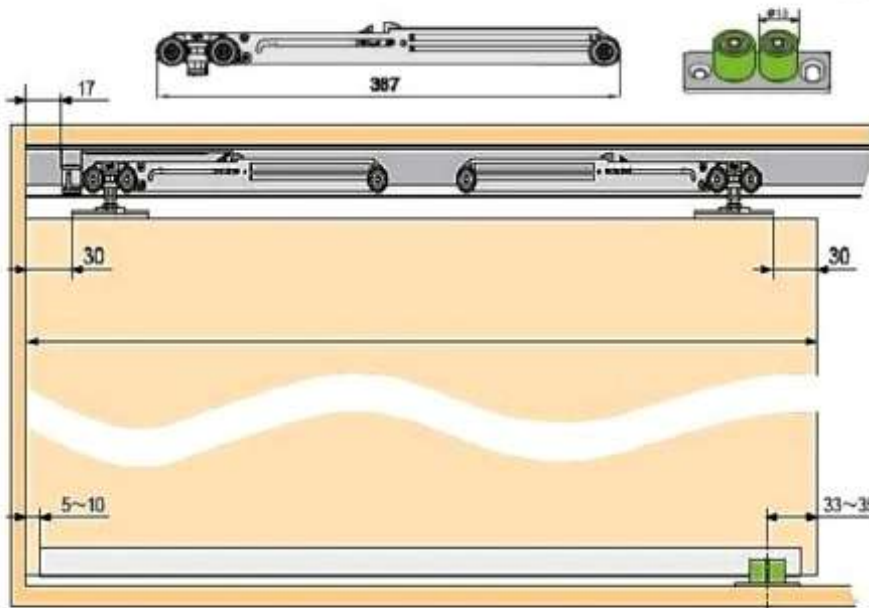
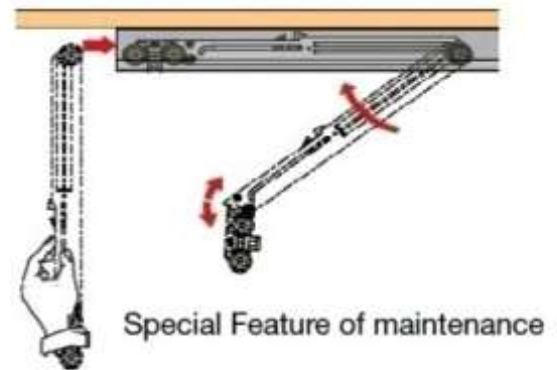
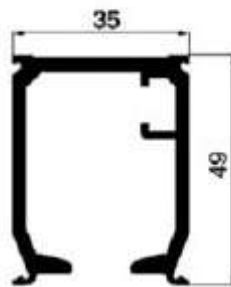

Range of applications

S5 Sliding Door Roller With Concealed Hanger

Order Code	Description
02.106.252.00	Soft Close
02.106.352.00	Without Soft Close

Product Features

- Smooth, steady and silent movement.
- Damper function exists while door opening and closing.
- Self cleaning in the track.
- Adjustable stopper device.
- Vertical and literal adjustment.
- Easy and simple maintenance.

Range of Applications

- For all single-leaf and two leaf sliding doors.
- For all materials, e.g wood, metal and framed door.
- Wall and ceiling mounted.
- Max weight 50kgs
- For door leaf >790mm for soft close
- For door leaf >520mm for without soft close



Without Soft Close



With Soft Close

Running Profile, Screw On

Finish : Silver anodized aluminium

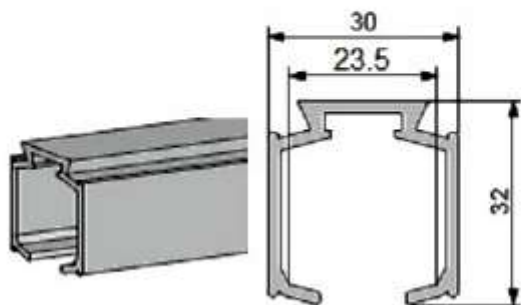

Order Code	Length
02.135.200.03	2.0m
02.135.300.03	3.0m
02.135.400.03	4.0m
02.135.600.03	6.0m

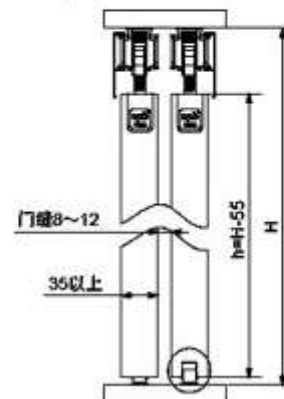
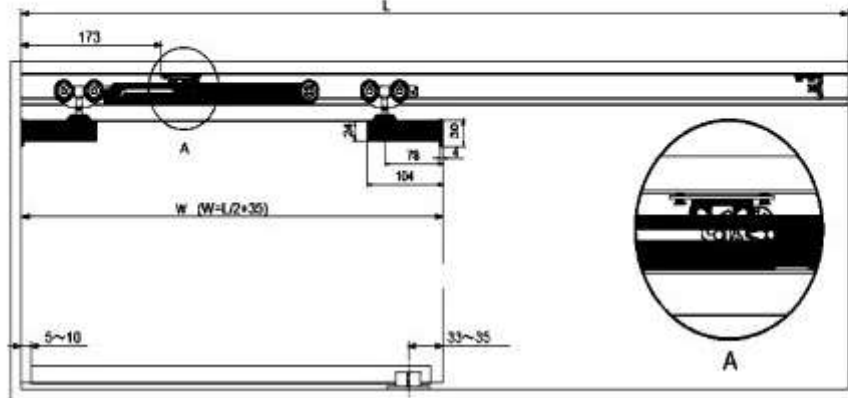
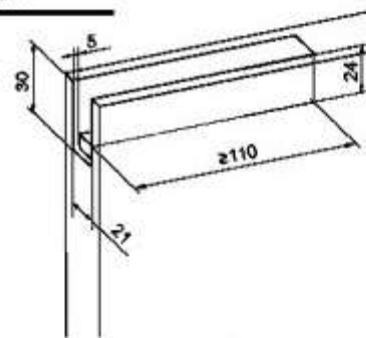
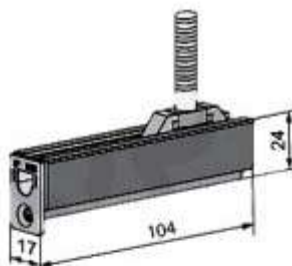
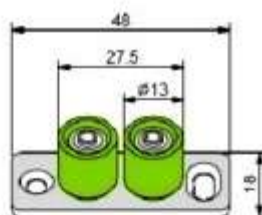

S5 Sliding Door Roller

Order Code	Description
02.106.052.00	Soft Close
02.106.152.00	Without Soft Close



Without Soft Close

Product Features

- Smooth, steady and silent movement.
- Damper function exists while door opening and closing.
- Self cleaning in the track.
- Adjustable stopper device.
- Vertical and literal adjustment.
- Easy and simple maintenance.

Range of Applications

- For all single-leaf and two leaf sliding doors.
- For all materials, e.g wood, metal and framed door.
- Wall and ceiling mounted.
- Max weight 50kgs
- For door leaf >790mm for soft close
- For door leaf >520mm for without soft close



With Soft Close

Running Profile, Screw On

Finish : Silver anodized aluminium

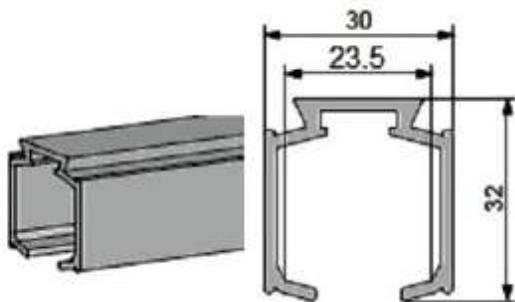

Order Code	Length
02.135.200.03	2.0m
02.135.300.03	3.0m
02.135.400.03	4.0m
02.135.600.03	6.0m

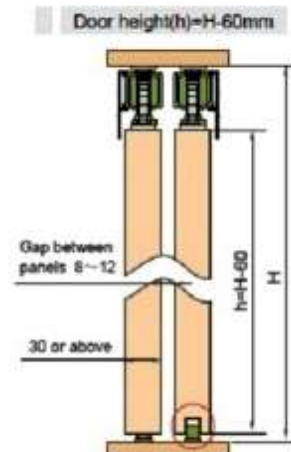
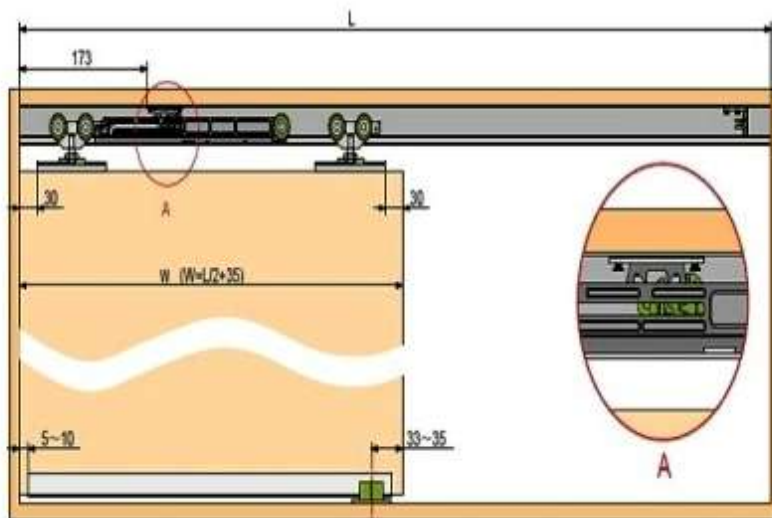
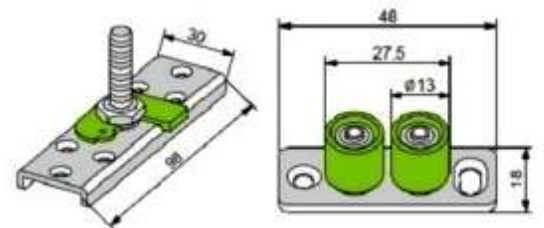

S5 Synchronised Sliding Door



Order Code	Description
02.106.552.00	2 Doors
02.106.652.00	3 Doors

Range of Applications

- For all materials, e.g wood, metal and framed door.
- Wall and ceiling mounted.
- Max weight 60kgs

Running Profile, Screw On
Finish : Silver anodized aluminium

Order Code	Length
02.135.200.03	2.0m
02.135.300.03	3.0m
02.135.400.03	4.0m
02.135.600.03	6.0m

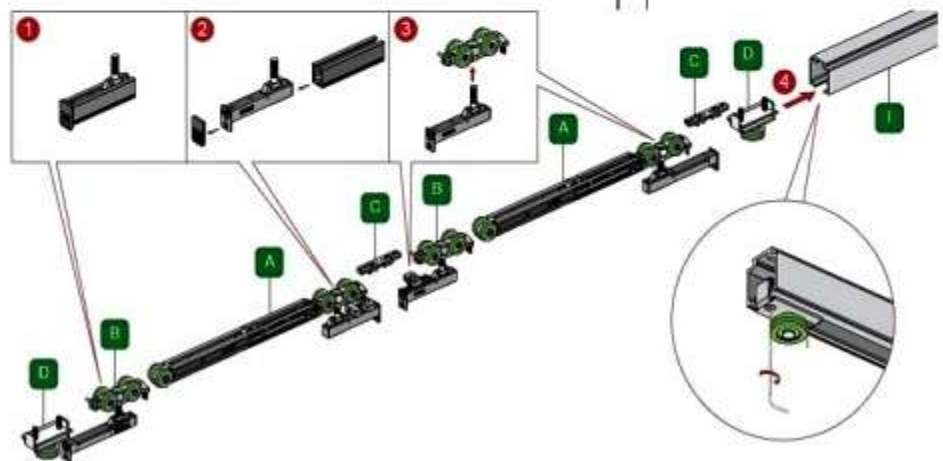
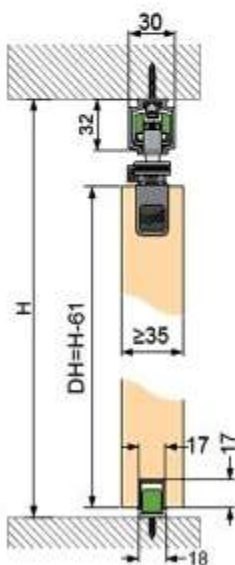
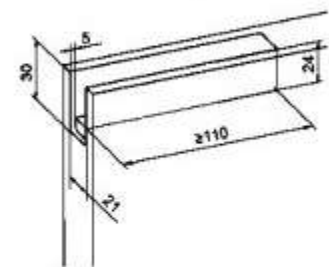
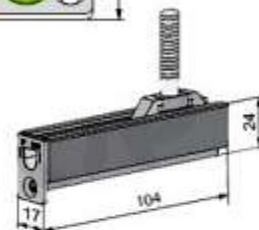
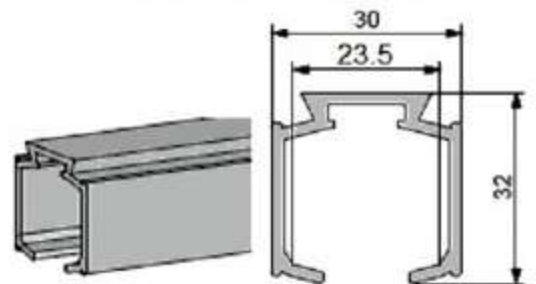
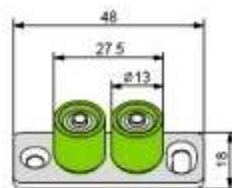

S11 Sliding Door 2-Way Soft Closing



Range of Applications

- For all single-leaf and two leaf sliding doors.
- For all materials, e.g wood, metal and framed door.
- Wall and ceiling mounted.
- Weight 50kgs – 80kgs
- For door leaf >>600mm

Order Code	Description
02.106.368.00	Roller

Running Profile, Screw On
Finish : Silver anodized aluminium

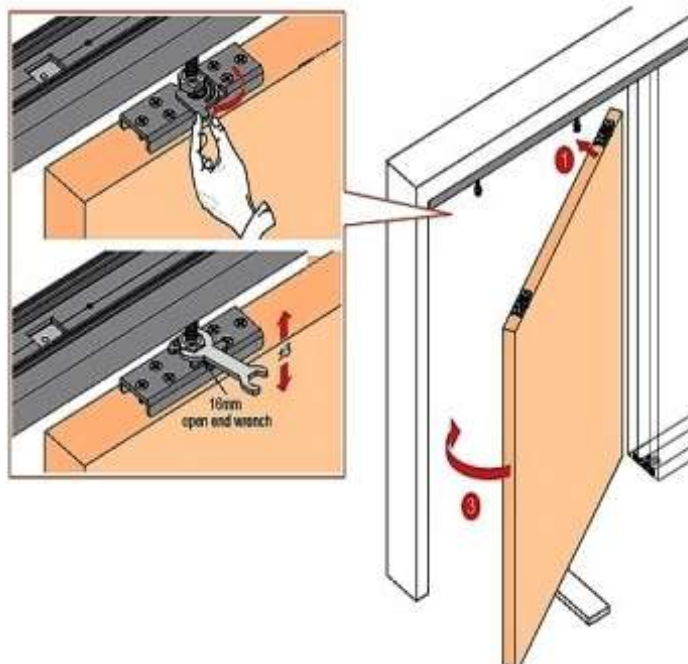
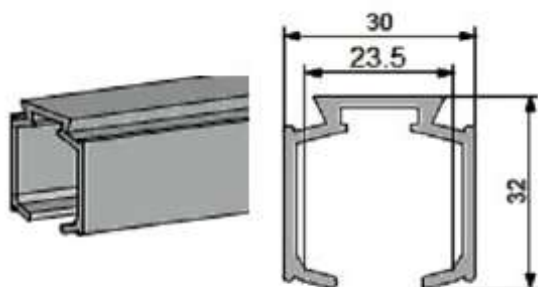

Order Code	Length
02.135.200.03	2.0m
02.135.300.03	3.0m
02.135.400.03	4.0m
02.135.600.03	6.0m

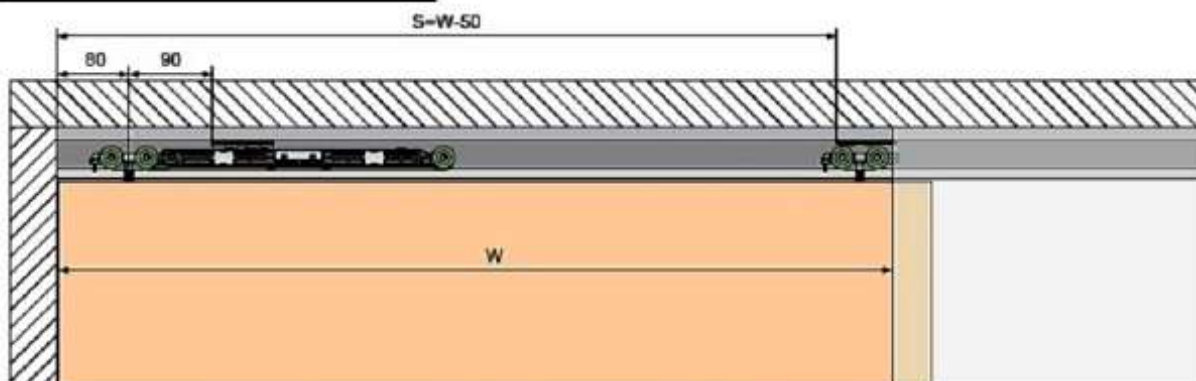

S13 Sliding Door 2 Way Soft Closing

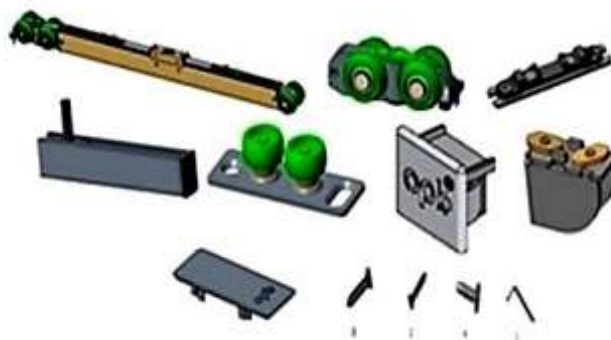

Range of Applications

- Wall and ceiling mounted.
- Max weight 160kgs

Order Code	Description
02.107.262.00	Roller
02.107.300.03	3m
02.107.600.03	6m TRACK

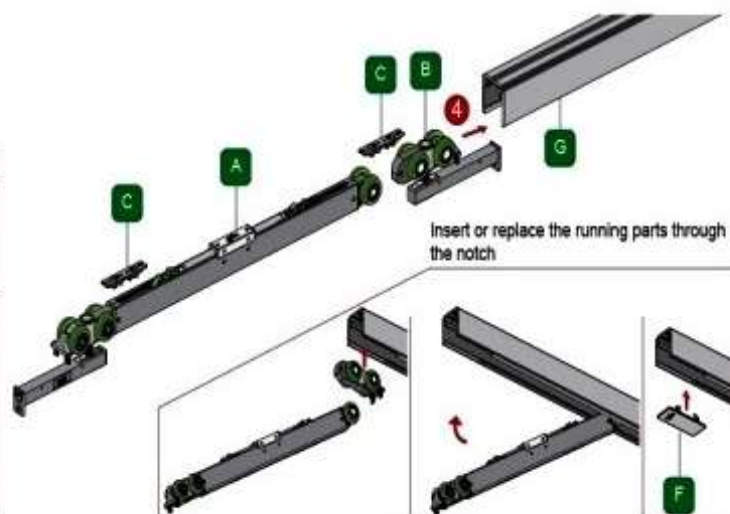
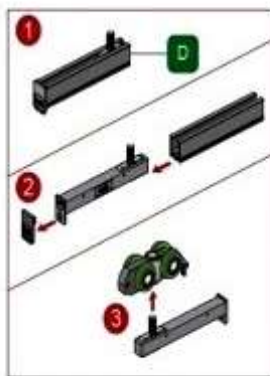
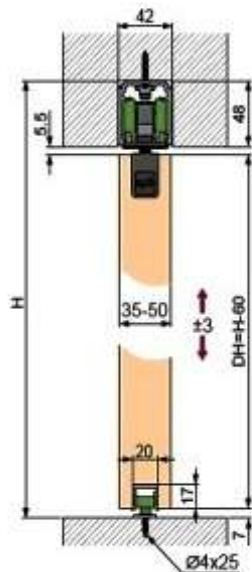
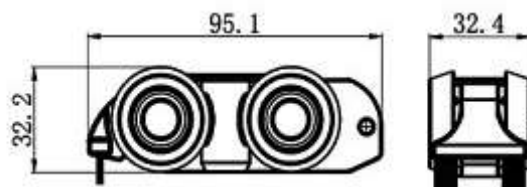
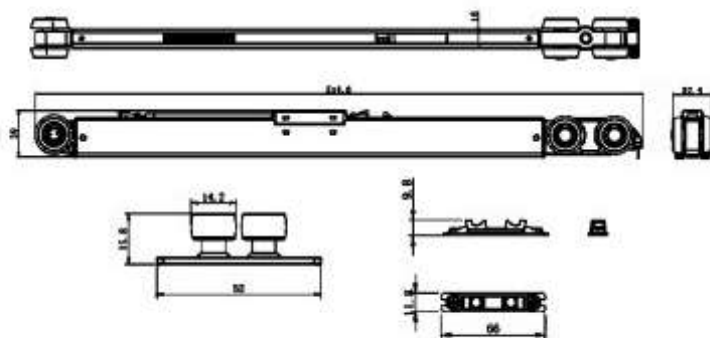
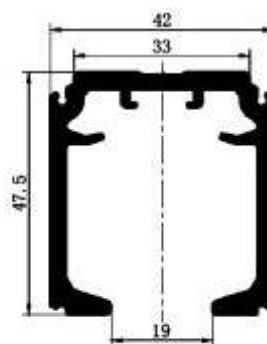

CZ1 Sliding Door Fitting

Product Features :

- Adopt fine casting technology, super strong bearing capacity, maximum can reach 500kgs.
- Open type hanging plate design, quick and easy installa
- For single and double wood sliding door.
- Door panel installation height is adjustable.
- Door weight : Single door « 500kg
- Door width : » 620mm



Order Code	Description
02.108.500.35	Roller
02.108.300.03	3m
02.108.600.03	6m

TRACK

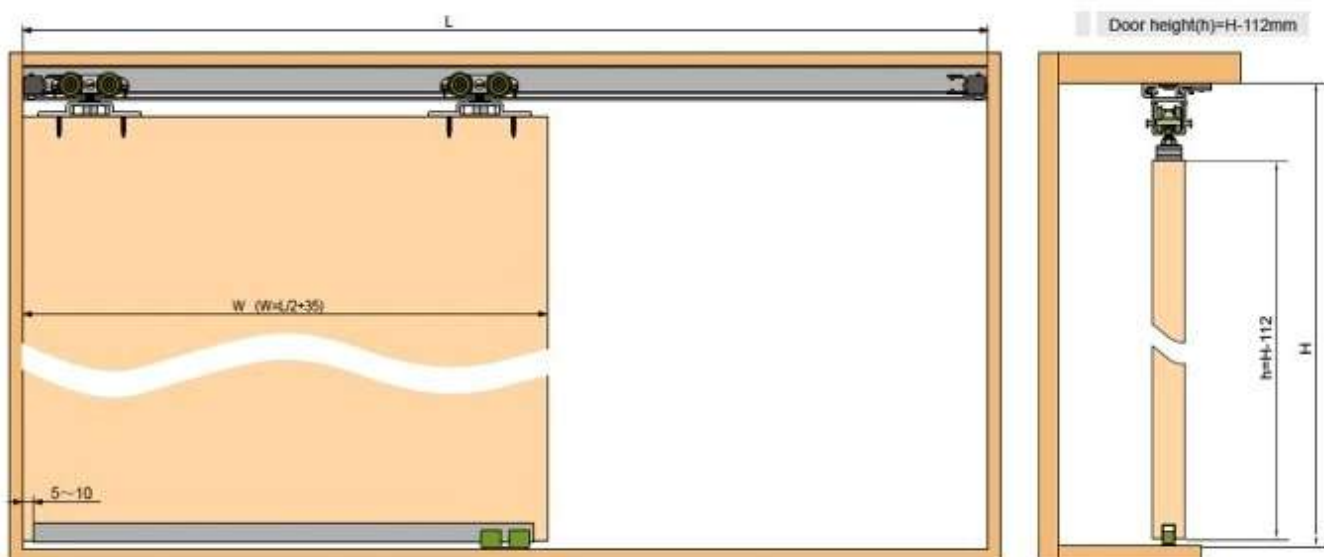
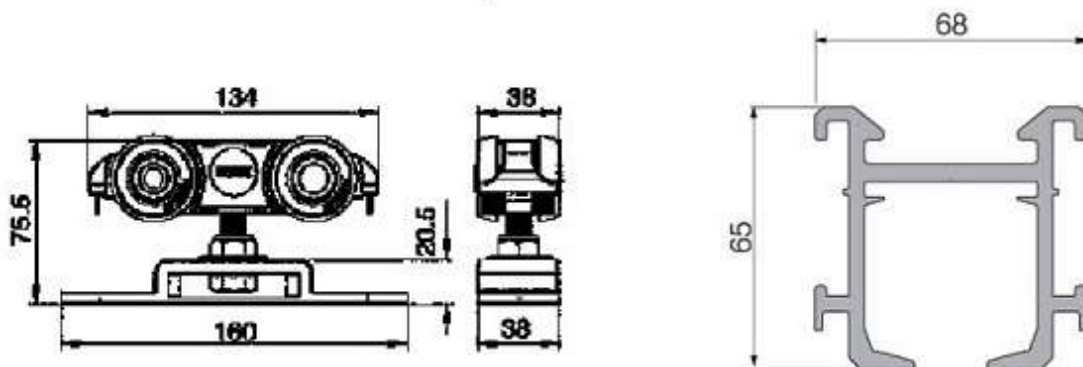

ACCURA 25F Folding Door Hardware System

ACCURA 25F

- Running gear body.
- Suitable for leaf weights up to max 25kgs.
- Min door thickness 25mm

Product Features

- Simple, trouble-free installation.
- Suspension with carrier for minimum installation height.
- Vertical and literal adjustment.

Range of Applications

- For all two leaf and maximum 6 leaves in a single running.
- For all wooden door.
- Wall and ceiling mounted.

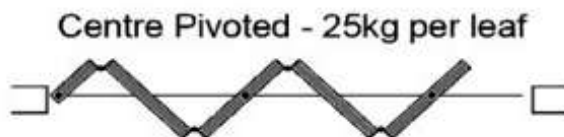
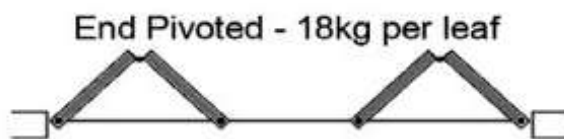

Should a centre pivot be required, the first leaf is to be half sized +30mm.

Order Code	Description
02.236.020.31	Roller
02.262.075.15	Top & Bottom Pivot

Additional Accessories



Order Code	Description
01.271.102.21	Flush Hinge
01.271.012.21	Flush Hinge with Handle
02.262.240.31	Folding Door Center Hinge

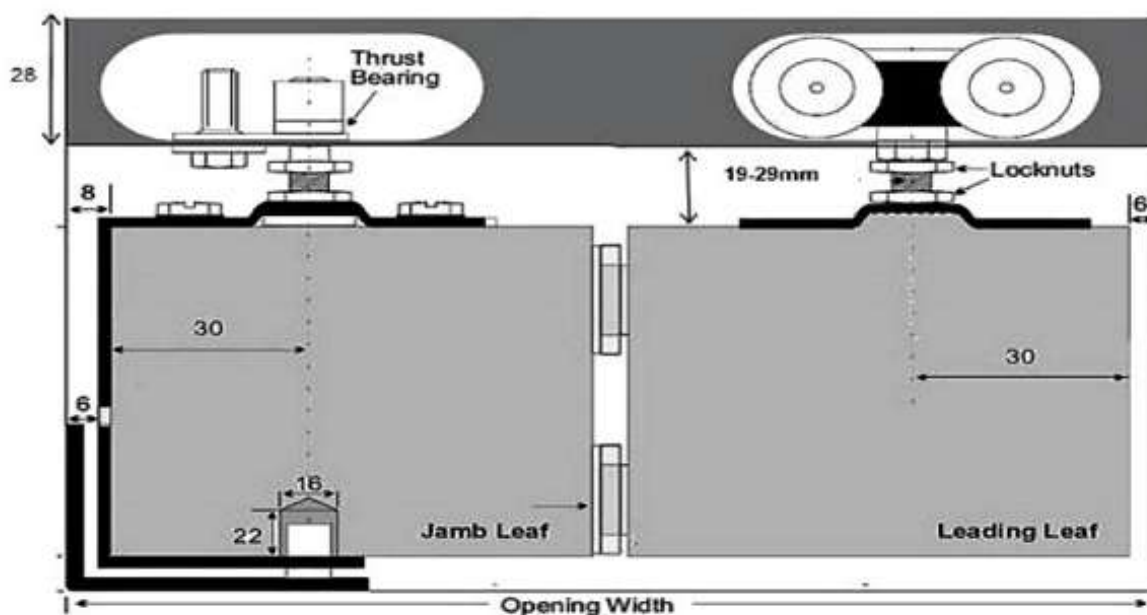

ACCURA Heavy Duty Sliding & Folding Door Fitting

Order Code	Length
02.260.200.03	2.0m
02.260.300.03	3.0m
02.260.400.03	4.0m
02.260.600.03	6.0m

Order Code	Wheel
02.260.042.24	Steel
02.260.042.39	Nylon

Product Features

- For flush timber, framed glass door and steel door.
- For thickness : 35 – 45mm
- Weight max : 200kg/panel (Sliding Door)
80kg/panel (Folding Door)

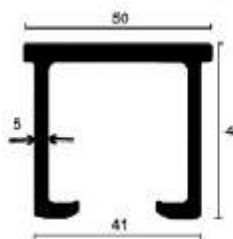
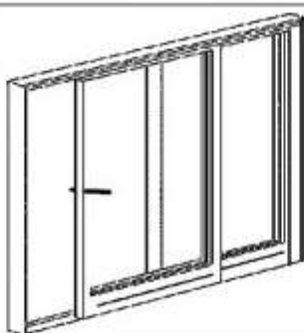

ACCURA GL283 Sliding Glass

Order code • **02.283.812.00**

- Sliding Glass Door Roller Fitting
- Glass Fitting Clamps

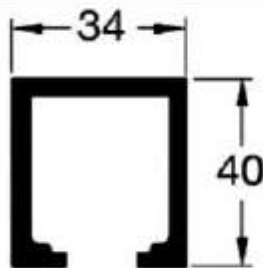

GL283 Sliding Track

Order code • **02.243.300.03**

Size : 3 meter



For glass thickness 8 - 12mm

Glass Notch Fitting

Order code • **02.281.010.03**

Size : M10 x 200 x 50mm

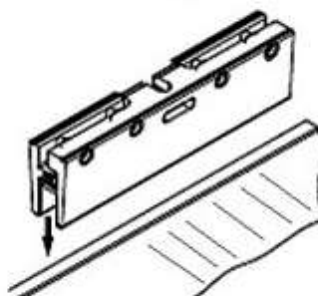

Sliding Glass Door Round Handle, SS

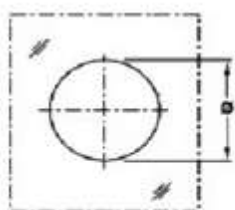

Order Code	Size a	Size b
02.291.050.21	50mm	65mm
02.291.058.21	58mm	68mm

Multi Panel Slide & Fold Roller 70kg

Order code • **02.245.070.34**

- Area of Application : For 3-leaf to 6-leaf wooden folding door
- Adjustment : Height adjustable
- Door thickness : \geq Minimum 32mm
- Door weight : Maximum 70kg
- Door width : 900mm for panel centre fold
: 600mm for panel end fold
- Installation : Suitable for light weight doors for odd and even number of leaves



Top Running Profile

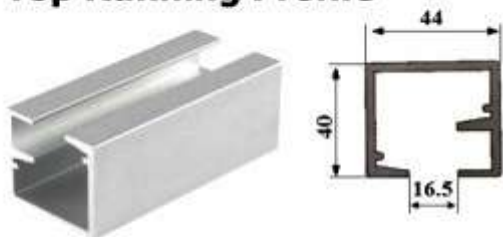

Additional Accessories

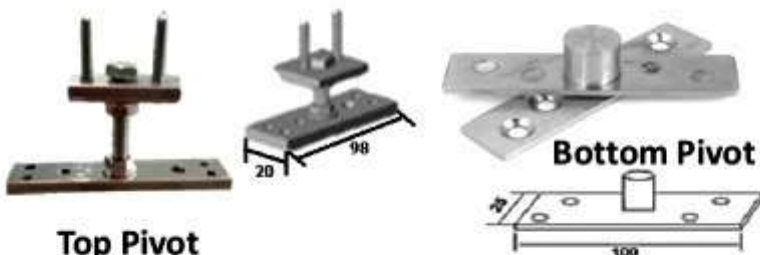

Bottom Running Profile

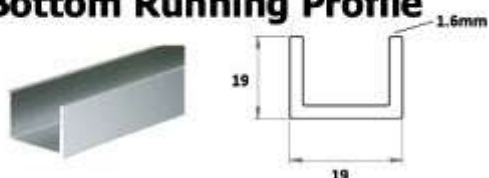

Top Pivot



Bottom Guide

Order Code	Length
02.245.070.15	Top Pivot 70kg
01.821.025.21	Bottom Pivot
02.261.015.24	Bottom Guide
01.271.012.21	Flush Hinge with Handle
01.271.102.21	Flush Hinge

Order Code Top Track	Order Code Bottom Track	Length
02.245.200.03	02.182.200.03	2.0m
02.245.300.03	02.182.300.03	3.0m
02.245.400.03	02.182.400.03	4.0m
02.245.500.03	02.182.500.03	5.0m
02.245.600.03	02.182.600.03	6.0m

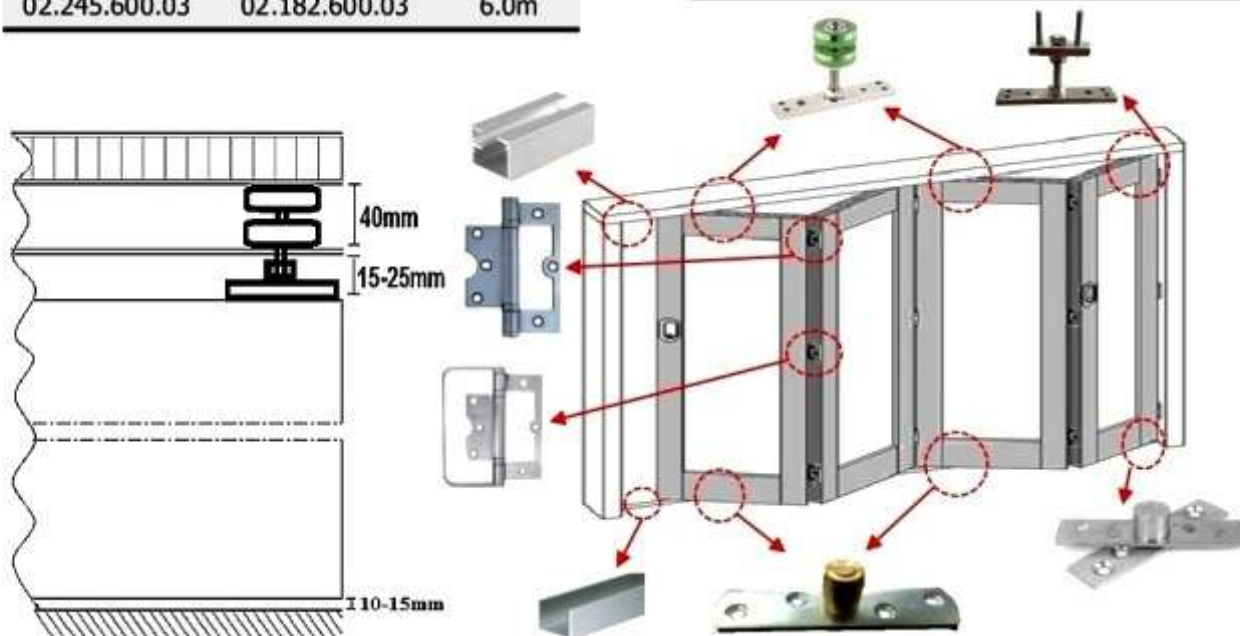

Multi Panel Slide & Fold Roller 100kg

Order code • **02.246.100.39**

- Area of Application : For 3-leaf to 6-leaf wooden folding door
- Adjustment : Height adjustable
- Door thickness : \geq Minimum 38mm
- Door weight : Maximum 100kg
- Door width : 800mm for panel centre fold
: 1000mm for panel end fold
- Installation : Suitable for light weight doors for odd and even number of leaves

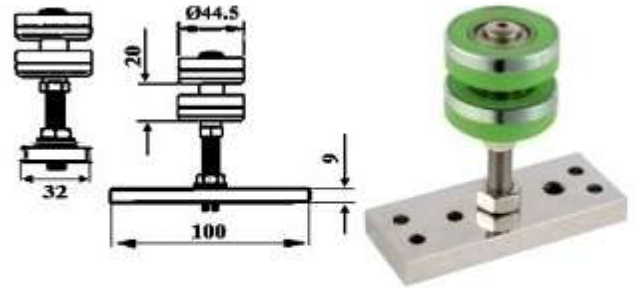

Top Running Profile



Additional Accessories

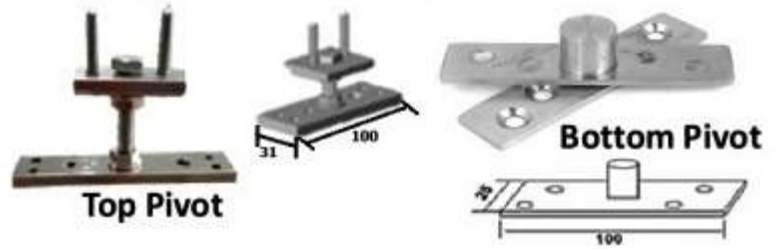

Bottom Running Profile

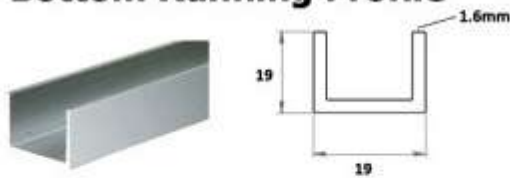

Order Code Top Track	Order Code Bottom Track	Length
02.246.200.03	02.182.200.03	2.0m
02.246.300.03	02.182.300.03	3.0m
02.246.400.03	02.182.400.03	4.0m
-	02.182.500.03	5.0m
02.246.600.03	02.182.600.03	6.0m

Order Code	Length
02.246.100.15	Top Pivot 100kg
01.821.025.21	Bottom Pivot
02.261.015.24	Bottom Guide
01.271.012.21	Flush Hinge with Handle
01.271.102.21	Flush Hinge

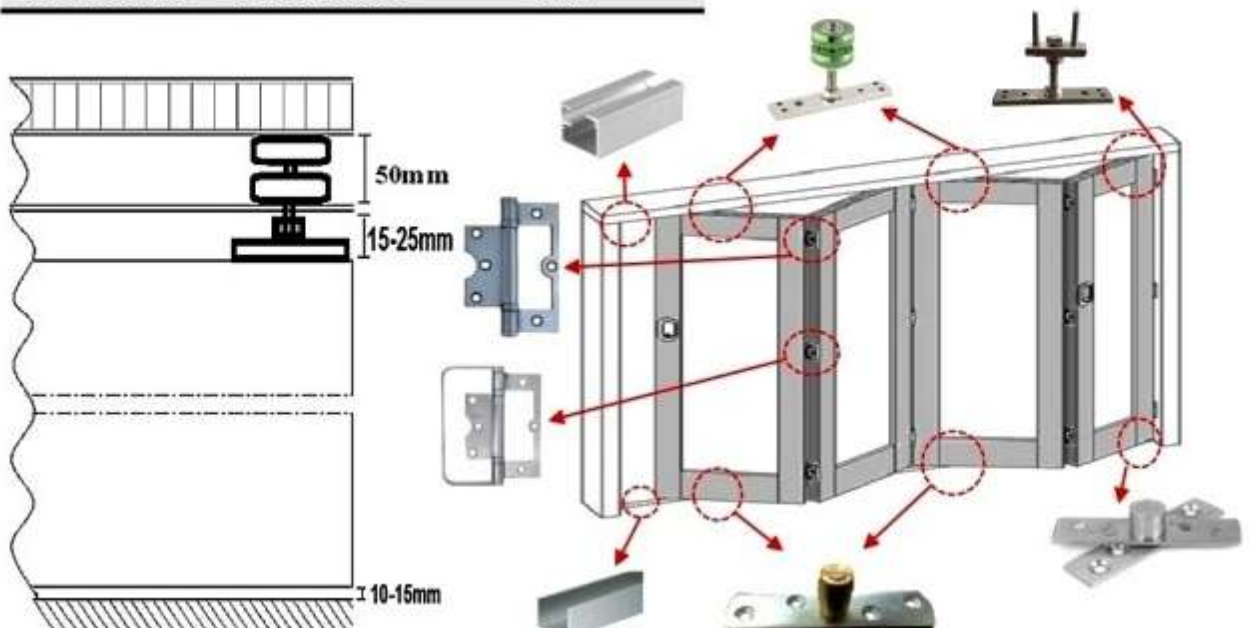

Multi Panel Slide & Fold Roller 150kg

Order code • **02.247.150.39**

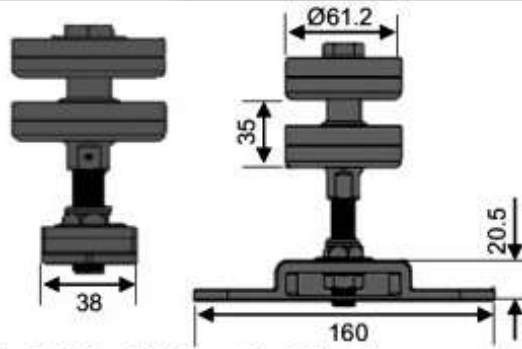

- Area of Application
- Adjustment
- Door weight
- Installation

: For 3-leaf to 6-leaf wooden folding door
 : Height adjustable
 : Maximum 150kg
 : Suitable for light weight doors for odd and even number of leaves

Running Profile

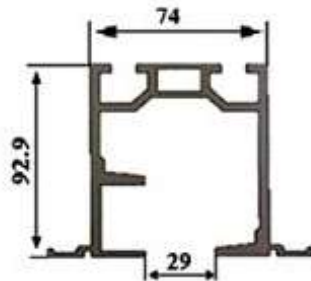

Order Code	Length
02.247.200.03	2.0m
02.247.300.03	3.0m
02.247.400.03	4.0m
02.247.600.03	6.0m

Additional Accessories



Order Code	Length
02.247.075.15	Track Connector 75 x 75mm
02.261.015.24	Brass Sliding Guide Ø15.5*18*25*100mm

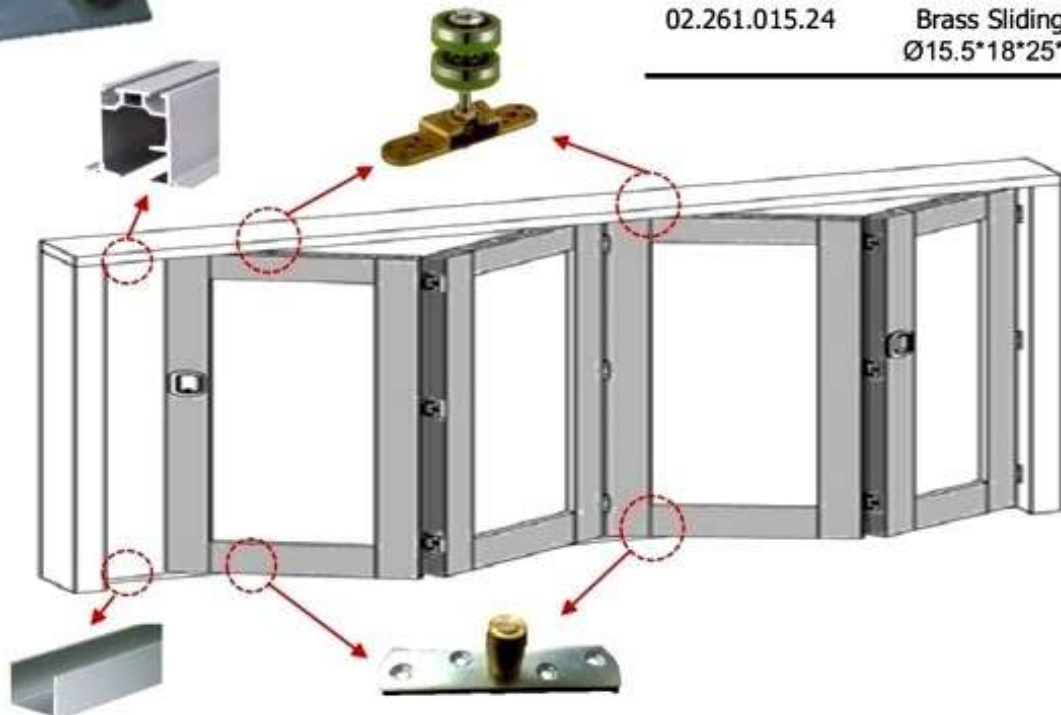

ACCURA 60-S Sliding Door Hardware System

For single leaf without running profile

Order Code	Article
02.100.060.00	Accura 60-S Kit

ACCURA 60-S

- Running gear body, white
- Suitable for leaf weights up to max 60kgs

Product Features

- Simple, trouble-free installation.
- Quiet operation with self cleaning rail.
- Outdoor installation possible.
- Suspension with carrier for minimum installation height.
- Vertical and lateral adjustment.

Range of Applications

- For all single-leaf and two leaf sliding doors.
- For all materials, e.g wood, metal and framed door.
- Wall and ceiling mounted.



Running Profile, Screw On

Silver Anodised Aluminium

Order Code	Length
02.131.200.03	2.0m
02.131.250.03	2.5m
02.131.300.03	3.0m
02.131.400.03	4.0m
02.131.600.03	6.0m

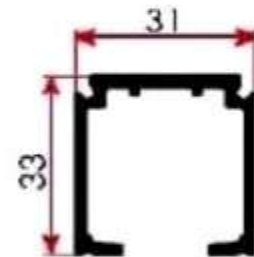

Running Profile, Screw On

Order Code	Article
02.150.041.39	Stop Buffer
02.151.051.15	Wall Bracket
02.150.031.39	Floor Guide

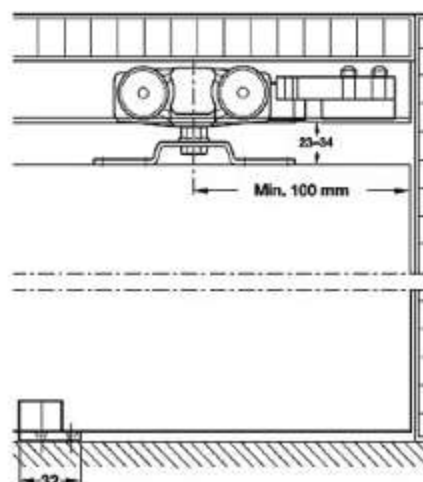
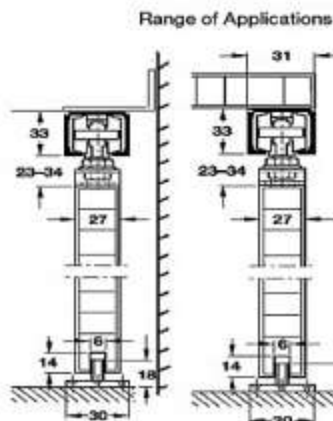

ACCURA 100-S Sliding Door Hardware System

For single leaf without running profile

Order Code	Article
02.100.100.00	Accura 100-S Kit

ACCURA 100-S

- Running gear body, white
- Suitable for leaf weights up to max 100kgs

Product Features

- Simple, trouble-free installation.
- Quiet operation with self cleaning rail.
- Maintenance-free needle roller bearing.
- Outdoor installation possible.
- Suspension with carrier for minimum installation height.
- Vertical and lateral adjustment.

Range of Applications

- For all single-leaf and two leaf sliding doors.
- For all materials, e.g wood, metal and framed door.
- Wall and ceiling mounted.



Running Profile, Screw On

Silver Anodized Aluminium

Order Code	Length
02.131.200.03	2.0m
02.131.250.03	2.5m
02.131.300.03	3.0m
02.131.400.03	4.0m
02.131.600.03	6.0m

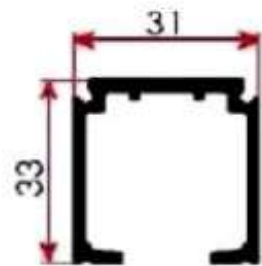

Additional Accessories

Order Code	Article
02.150.041.39	Stop Buffer
02.151.051.15	Wall Bracket
02.150.031.39	Floor Guide

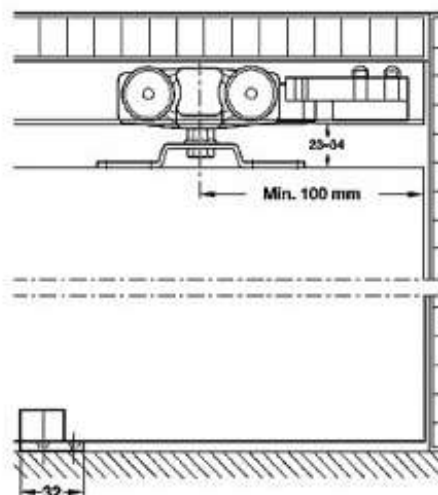
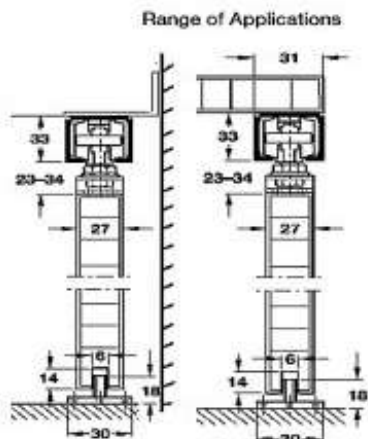

ACCURA 160-S Sliding Door Hardware System

Order Code	Article
02.100.160.00	Accura 160-S Kit

- ACCURA 160-S**
- Running gear body, white
 - Suitable for leaf weights up to max 160kgs

- Product Features**
- Simple, trouble-free installation.
 - Quiet operation with self cleaning rail.
 - Outdoor installation possible.
 - Suspension with carrier for minimum installation height.
 - Vertical and lateral adjustment.

- Range of Applications**
- For all single-leaf and two leaf sliding doors.
 - For all materials, e.g wood, metal and framed door.
 - Wall and ceiling mounted.



Running Profile, Screw On

Silver Anodized Aluminium

Order Code	Length
02.132.200.03	2.0 m
02.132.300.03	3.0 m
02.132.400.03	4.0 m
02.132.600.03	6.0m

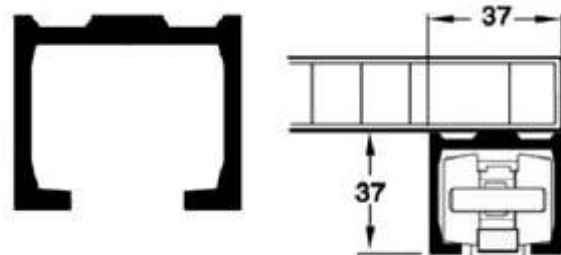



Additional Accessories

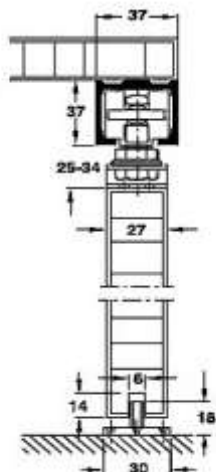
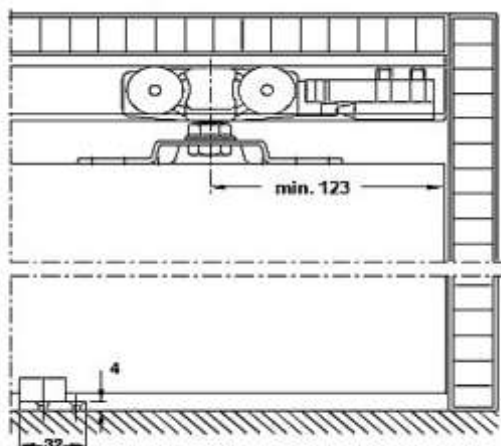

Order Code	Article
02.151.051.15	Wall Fixing Bracket

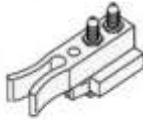

1 Pack have :

-  x 2pcs Roller
-  x 2pcs Stopper
-  x 1pc Floor Guide



SUNBEST TRADING

No. 49-1, Jalan Kuchai Jaya 1,
Taman Kuchai Jaya,
58200 Kuala Lumpur, Malaysia.
Tel/HP: +6016626 9488/+6017247 1989
Email: info.sunbest@gmail.com
Website: sunbest2u.com

